

# LASERSMART

EN

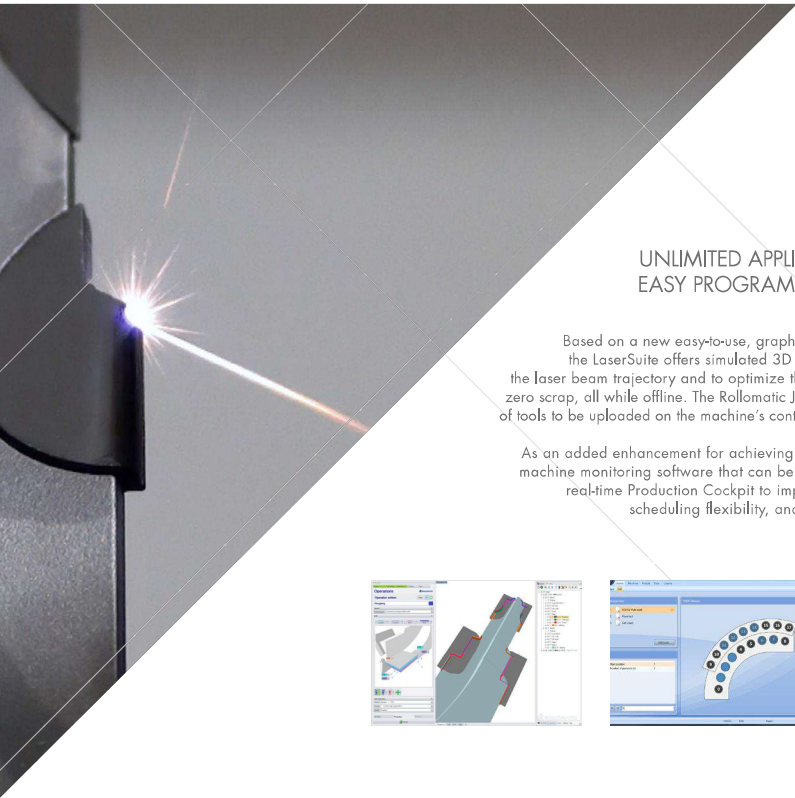

## LASERSMART 510

UNLIMITED APPLICATIONS WITH LASERSUITE -  
EASY PROGRAMMING AND 3D SIMULATION

Based on a new easy-to-use, graphical interface, the software provided with the LaserSuite offers simulated 3D operations and allows the user to inspect the laser beam trajectory and to optimize the cycle time before production to ensure zero scrap, all while offline. The Rollomatic JobManager program allows various types of tools to be uploaded on the machine's control and allows for Unattended Production.

As an added enhancement for achieving high productivity, RMonitor is an add-on machine monitoring software that can be integrated with the LaserSmart 510 as a real-time Production Cockpit to improve the machine's productivity, provide scheduling flexibility, and remotely display manufacturing history.

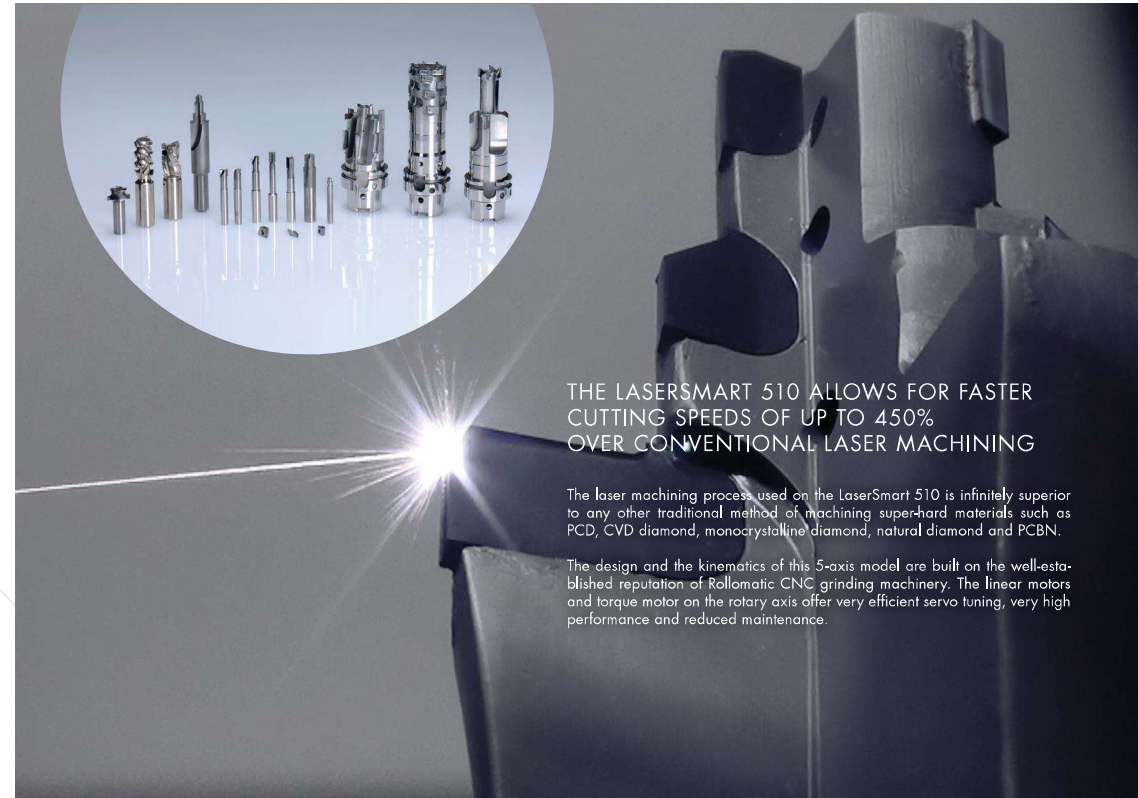
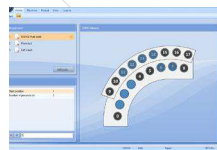
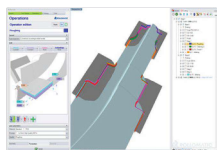

THE LASERSMART 510 ALLOWS FOR FASTER  
CUTTING SPEEDS OF UP TO 450%  
OVER CONVENTIONAL LASER MACHINING

The laser machining process used on the LaserSmart 510 is infinitely superior to any other traditional method of machining super-hard materials such as PCD, CVD diamond, monocrystalline diamond, natural diamond and PCBN.

The design and the kinematics of this 5-axis model are built on the well-established reputation of Rollomatic CNC grinding machinery. The linear motors and torque motor on the rotary axis offer very efficient servo tuning, very high performance and reduced maintenance.

The technology of **chip breaker machining** ensures surface finish quality well above industry standards.



Unique laser process creates **razor-sharp cutting edges** with a radius of less than 1 µm.

The programming of negative chamfers (K-lands) extends the applications panel of the LaserSmart 510. Unique to the market, **programmable defined cutting edge** preparations offer total freedom and flexibility to enhance your cutting tool's performance during machining.

**Cylindrical margins** are machined all within a single clamping.

The **machining process is offset-independent** and is unrelated to the amount of offset on the raw brazed PCD material. There is no increase in cycle time and no additional blank preparation is necessary within the machining process.

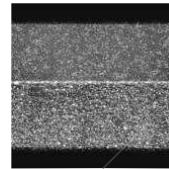

Sharp Edge

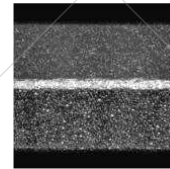

Defined Edge



Chip breaker

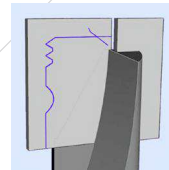

Unmachined tool

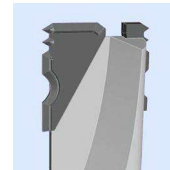

Machined tool



Cassette drawer



HSK63 magazin



Cassette for shank tools or inserts



Vision system

## AUTOMATION SOLUTIONS FOR PERFORMANCE

The use of a full 6-axis robot system provides high flexibility and compactness to the LaserSmart 510, allowing it to accommodate several performance-enhancing systems:

- HSK63 station including 17 tool magazine
- Round shaft automation with a user-friendly drawer for tool loading
- Extremely simple handling for interchangeable inserts

The change-over between these last two systems take only a few seconds, thanks to a minimal set-up.

The integration of cameras guarantees a perfect visibility of the robot's operation directly from the control screen. This vision system allows to supervise all the stages located inside the machine and provide the necessary support to the customers remotely, particularly for the programming of the probing sequences.

## SPECIFICATIONS

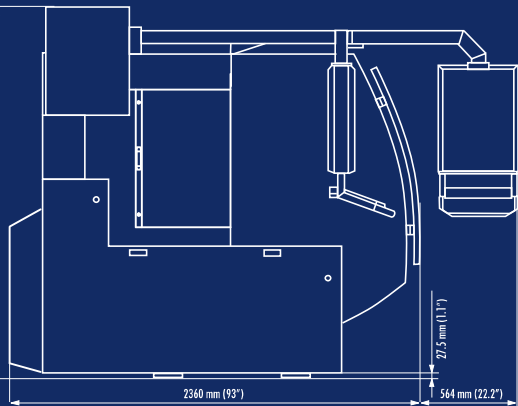
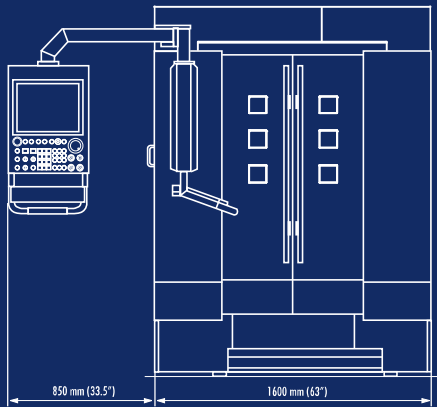

### MACHINING RANGE

Diameter range 2.0 - 80.0 mm (.08" - 3.2")

Overall tool length up to 190 mm (7.5")

**CONTROL** FANUC 30iMB

Z axis Type Fanuc servo motor and ballscrew

Stroke 100 mm (3.9")

Fast travel 20 m/min (787"/min)

Encoder Linear scale 0.00005 mm (.000002")

Y axis Type Linear motor, oil cooled

Stroke 400 mm (15.7")

Fast travel 30 m/min (1180"/min)

Encoder Linear scale 0.00005 mm (.000002")

X axis Type Linear motor, oil cooled

Stroke 125 mm (5")

Fast travel 30 m/min (1180"/min)

Encoder Linear scale 0.0001 mm (.000004")

B axis Type Servo motor, oil cooled

Stroke 260° (+130°)

Fast rotation 10000°/min

Encoder Rotary scale 0.0001°

C axis Type Servo motor, oil cooled

Stroke Continuous

Fast rotation 1000 rpm

Encoder on AC motor, 0.0001°

### LASER HEAD

Laser Scanner with integrated digital position detector and digital servo control board

Oil cooling of the electronics and the galvanometer scanners

### TOOL CLAMPING

Clamping Collet SK 32, Nann

Clamping HSK63 (A, C, E, F)

### ROBOT LOAD & UNLOAD (optional)

Number of tools Up to 1000 (3 cassettes)

Shank diameter 2.0 - 32.0 mm (.08" - 1.25")

Clamping Pneumatic

HSK Tool magazine HSK63, max. 18 tools

### MACHINE

L x W x H 2160 x 1600 x 2151 mm

(85" x 63" x 84.7")

Weight 3200 kg (7050 lbs)

Total power Maximum 5 kW

3 x 400V/25A

Laser product class 1

Classified 60825-1 2007

\* Specifications are subject to change without notice

